



# Assembly Instruction

ITEM NO.UM1040A GREY

## DOUBLE RECLINING SOFA WITH DROP-DOWN CUP HOLDERS

NOTE: Do not use power tools for assembly. Power tools increase the risk of over tightening which lead to splitting or cracking the wood.

### PART LIST

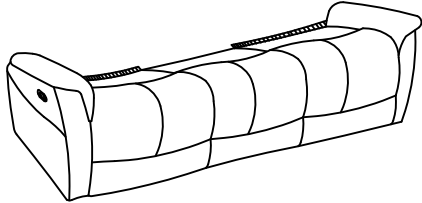
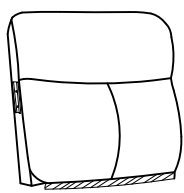
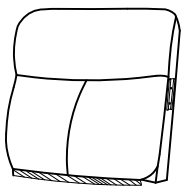
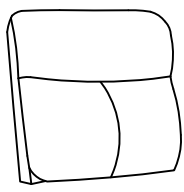
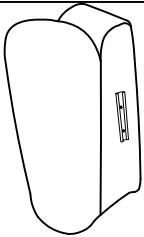
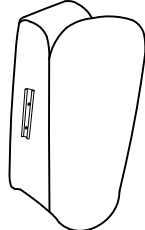
NO.	DRAWING	QTY	DESCRIPTION
A		1	SEAT
B		1	LSF BACK REST
C		1	RSF BACK REST
D		1	MIDDLE BACK REST
E		1	LSF EAR
F		1	RSF EAR

# Please follow the drawings below to assemble the item

Step 1: Align the female brackets at the back onto the male brackets at the seat, insert and push to the end, make sure the brackets are secured in position.

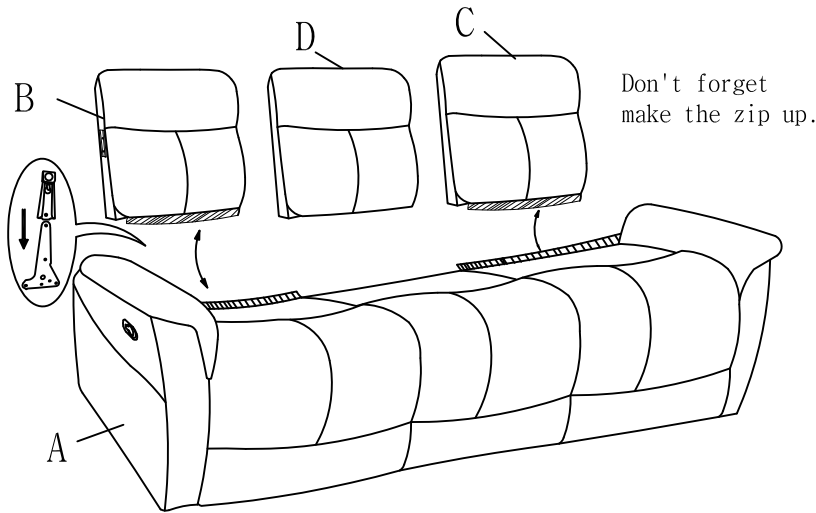

Step 2: Please insert the LSF ear and RSF ear to the back rest and make sure it is secured in position.

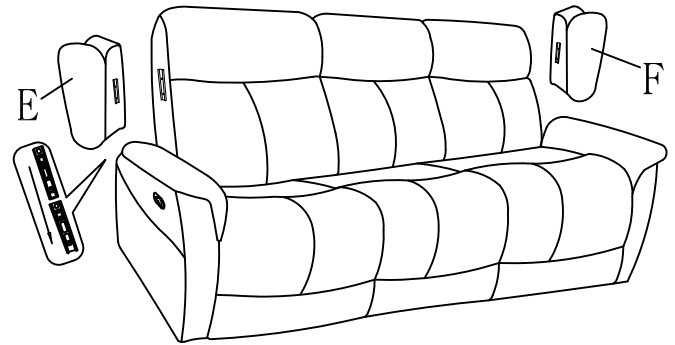

Step 3: Completed.

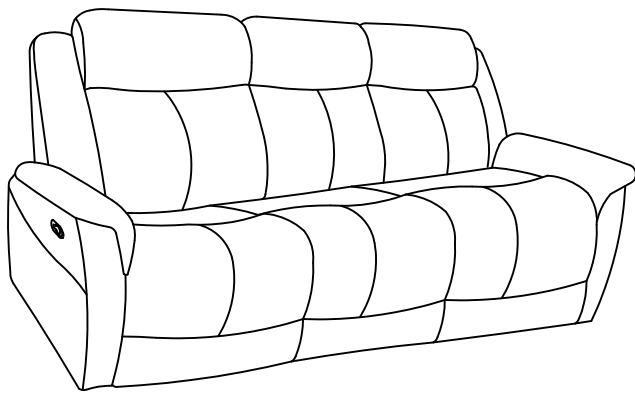

Step 4: Pull the middle back to the seat to use cup holder function.

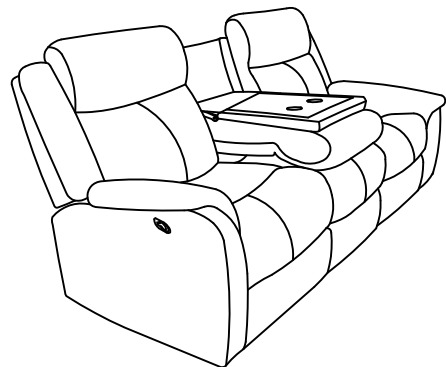

## CARE INSTRUCTION FOR FABRIC FURNITURE

- Avoid exposing furniture directly to sunlight or heating and air conditioning outlets. Exposure to sunlight or heating and air conditioning outlets will fade/damage fabric.
- Wipe gently with a damp soft cloth to remove dust, dirt and any grime buildup.



For items use on wooden floor, hard surfaces or carpets, it is recommended to install protective pads under all legs and supports to avoid/prevent from damages/scratches and discoloration.